

6. Rõhu-, kaitse-, voolu- ja vastuventiilid

Rõhukaitseventiilid

Tüüp	Vooluhulk	Max surve	Liides	Muu
MVLP 40 L14	40 l/min	350 bar	R 1/4"	Seadekruviga
MVLP 40 L38	40 l/min	350 bar	R 3/8"	Seadekruviga
MVLP 40 L12	40 l/min	350 bar	R 1/2"	Seadekruviga
MVLP 80 L34	80 l/min	350 bar	R 3/4"	Seadekruviga
MVLP 130 L34	130 l/min	350 bar	R 3/4"	Seadekruviga
MVLP 130 L10	130 l/min	350 bar	R 1"	Seadekruviga
MDSTR 34	150 l/min	300 bar	R 3/4"	Seadekruviga

Lisateave: Survepiirajad alumiinium- ja teraspesadega.

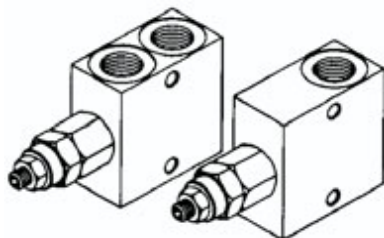

Survevähendusventiilid

Tüüp	Vooluhulk	Max surve	Max vähendussurve	Liides
MRP 25-38	25 l/min	300 bar	210 bar	R 3/8"
MRP 25-12	25 l/min	300 bar	210 bar	R 1/2"
MCRC1R	90 l/min	320 bar	250 bar	R 1/2"

Kaksiksurvepiirajad

Tüüp	Vooluhulk	Max surve	Liides	Muu
MVLP 40 DI38	40 l/min	300 bar	R 3/8"	Seadekruviga
MVLP 40 DI12	40 l/min	300 bar	R 1/2"	Seadekruviga
MVLP 80 DI34	80 l/min	300 bar	R 3/4"	Seadekruviga

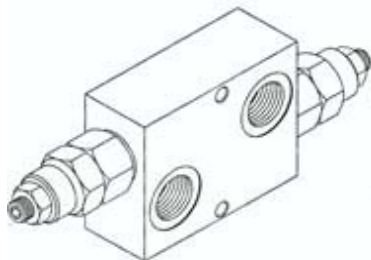

www.hydropower.ee

Topeltsurvepiirajad paagiliidesega

Tüüp	Vooluhulk	Max surve	Liides	Muu
MVLP 40 DA12	40 l/min	350 bar	R 1/2"	Seadekruviga
MVLP 80 DA34	80 l/min	350 bar	R 3/4"	Seadekruviga

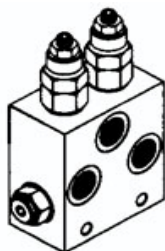

Rõhukaitseventiilid hüdmootoritele

Tüüp	Max surve	Muu
MVLP-40-S-FMD	350 bar	1-poolne
MVLP-40-D-FMD	350 bar	2-poolne

Rõhukaitseventiil teraskorpusega

Tüüp	Vooluhulk	Max surve	Liides	Muu
MVMP 3/8	45 l/min	300 bar	R 3/8	Seadekruviga
MVMP 1/2	70 l/min	300 bar	R 1/2	Seadekruviga
MVMP 3/4	120 l/min	300 bar	R 3/4	Seadekruviga
MVMPP 3/4	120 l/min	400 bar	R 3/4	Seadekruviga
MVMPP 1	180 l/min	400 bar	R 1	Seadekruviga

Kaksik rõhukaitseventiil teraskorpusega

Tüüp	Vooluhulk	Max surve	Liides	Muu
MVMPD 1/2T	70 l/min	300 bar	R 1/2	Seadekruviga

Ohuventiilblokk

Tüüp	Vooluhulk	Max surve	Liides
MB000770	80 l/min	300 bar	R 1/2"

Rõhukaitseventiilide vedrud

Vedru	Standardseadmine baarides (Q=5 l/min)	Seadmisala baarides	Vedru värv
01	80	20-100	Valge
02 standard	180	40-250	Kollane
03	250	60-350	Must

www.hydropower.ee

Vooluhulga jagamisventiilid

Tüüp	Vooluhulk	Jagamissuhe	Max surge	Liides
MDTP 6-20	7-20 l/min	50:50	315 bar	R 3/8"
MDTP 6-35	12-35 l/min	50:50	315 bar	R 3/8"
MDTP 6-50	16-50 l/min	50:50	315 bar	R 3/8"
MDTP 10-70	35-70 l/min	50:50	315 bar	R 1/2"

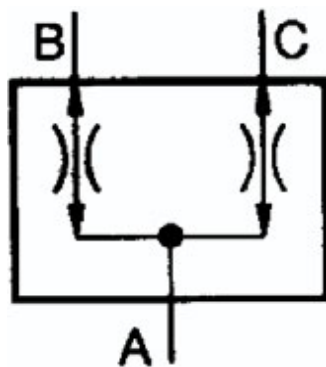

Rõhuga kompenseeritud voolujagamisventiilid

3 kanaliga ventiilid

Tüüp	Vooluhulk	Max surge	Liides
MFC 38	30 l/min	210 bar	R 3/8"
MFC 12	60 l/min	210 bar	R 1/2"
MFC 34	110 l/min	210 bar	R 3/4"
MRFP 50-FMD	50 l/min	270 bar	mootoriga sobitamine
MRFP 50-38B	50 l/min	270 bar	R 3/8"
MRFP 50-12B	50 l/min	270 bar	R 1/2"
MRFP 90-34B	90 l/min	270 bar	R 3/4"
MRFP-G	80 l/min	350 bar	R 3/4"
MRF-GV-A	80 l/min	350 bar	R 3/4"

Lisateave: RF-GV-A mudelis seadistatav rõhukaitseventiil

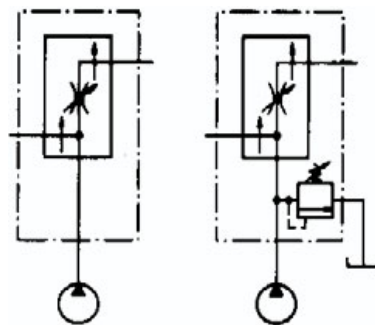
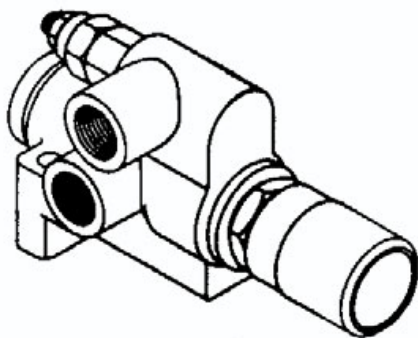

2 kanaliga ventiilid, kompenseeritav vooluhulga regulaator

Tüüp	Vooluhulk	Max surge	Liides
MVCST-14	1-10 l/min	250 bar	R 1/4"
MVCST-38	1-18 l/min	250 bar	R 3/8"
MVCST-12	1-33 l/min	250 bar	R 1/2"

Vastuventiilid

Tüüp	Vooluhulk	Max surge	Liides	Avanemissurve
MFPR 14	12 l/min	350 bar	R 1/4"	0,5 bar
MFPR 38	30 l/min	350 bar	R 3/8"	0,5 bar
MFPR 12	45 l/min	350 bar	R 1/2"	0,5 bar
MFPR 34	85 l/min	350 bar	R 3/4"	0,5 bar
MFPR 1	140 l/min	250 bar	R1"	0,5 bar
MFPR 1 1/4	200 l/min	250 bar	R1 1/4"	0,5 bar
MFPR 1 1/2	310 l/min	210 bar	R1 1/4"	0,5 bar

Lisateave: Vastuventiilid on võimalik saada ka 1,2-baarise, 2,5-baarise, 5-baarise ja 10-baarise avanemissurvega

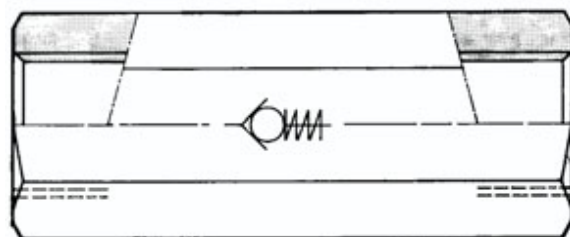

Vastuventiilpadrunid

Tüüp	Vooluhulk	Max surge	Liides
MFPRI 14	15 l/min	350	R 1/4" väliskeere
MFPRI 38	30 l/min	350	R 3/8" väliskeere
MFPRI 12	45 l/min	350	R 1/2" väliskeere
MFPRI 34	80 l/min	350	R 3/4" väliskeere

Takistus-vastuventiilid

Tüüp	Vooluhulk	Max surge	Liides
MVSF 14	20 l/min	350	R 1/4"
MFPT 14	25 l/min	350	R 1/4" terasest
MVSF 38	40 l/min	350	R 3/8"
MFPT 38	50 l/min	350	R 3/8" terasest
MVSF 12	60 l/min	350	R 1/2"
MVSF 34	100 l/min	350	R 3/4"

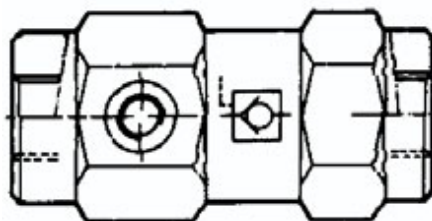

Lukkventiilid

Tüüp	Vooluhulk	Max surge	Liides	Avanemissuhe
MFPS 14	12 l/min	350 bar	R 1/4"	1:9
MFPS 38	30 l/min	310 bar	R 3/8"	1:6
MFPS 12	45 l/min	310 bar	R 1/2"	1:4,5
MFPS 34	85 l/min	300 bar	R 3/4"	1:3,7

Kaksiklukkventiilid

Tüüp	Vooluhulk	Max surge	Liides	Avanemissuhe
MFPD 14	12 l/min	350 bar	R 1/4"	1:4
MFPD 38	30 l/min	300 bar	R 3/8"	1:6
MFPD 38-20L	20 l/min	300 bar	R 3/8"	1:4
MFPD 12	45 l/min	300 bar	R 1/2"	1:4
MFPD 34	85 l/min	280 bar	R 3/4"	1:3,6
MFPDL 38	30 l/min	350 bar	R 3/8"	1:7
MFPDL 12	45 l/min	350 bar	R 1/2"	1:3,5

Lisateave: FPDL kaksiklukkventiilis on läbiminevad kanalid.



Voolikukaitseventiilid

Tüüp	Vooluhulk	Max surge	Liides
MFFP 14	25 l/min	350 bar	R 1/4"
MFFP 38	50 l/min	350 bar	R 3/8"
MFFP 12	80 l/min	350 bar	R 1/2"
MFFP 34	150 l/min	350 bar	R 3/4"
MFFP 1	200 l/min	300 bar	R 1"

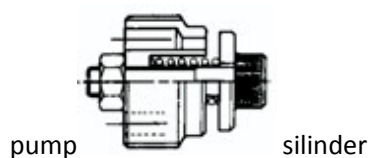

Voolikukaitseventiilide padrunid

Tüüp	Vooluhulk	Max surge	Liides
MFFP 14	25 l/min	350 bar	R 1/4" väliskeere
MFFP 38	50 l/min	350 bar	R 3/8" väliskeere
MFFP 12	80 l/min	350 bar	R 1/2" väliskeere
MFFP 34	150 l/min	350 bar	R 3/4" väliskeere
MFFP 1	200 l/min	300 bar	R 1" väliskeere

www.hydropower.ee

Takistusventiilid

Tüüp	Vooluhulk	Max surge	Liides
MFPSB 14	15 l/min	300 bar	R 1/4"
MFPSB 38	25 l/min	300 bar	R 3/8"
MFPSB 12	40 l/min	280 bar	R 1/2"
MFPB 14	12 l/min	300 bar	R 1/4"
MFPB 38	30 l/min	300 bar	R 3/8"
MFPB 12	45 l/min	280 bar	R 1/2"
MFPB 34	85 l/min	250 bar	R 3/4"



Takistusventiilid

Tüüp	Vooluhulk	Max surge	Liides
MFPSU 14	15 l/min	300 bar	R 1/4"
MFPSU 38	25 l/min	300 bar	R 3/8"
MFPSU 12	40 l/min	280 bar	R 1/2"
MFPU 14	12 l/min	300 bar	R 1/4"
MFPU 38	30 l/min	300 bar	R 3/8"
MFPU 12	45 l/min	280 bar	R 1/2"
MFPU 34	85 l/min	250 bar	R 3/4"



Manomeetri ventiilid

Tüüp	Max surve	Liides	Muu
MFPE 14	350 bar	R 1/4"	sirge, püsiv
MFPE 1G 04	300 bar	R 1/4"	sirge, suunatav
MFPEA 1G 04	300 bar	R 1/4"	90-kraadine nurk, suunatav

Koormusele laskumise ventiilid

Tüüp	Vooluhulk	Max surve	Liides	Avanemissuhe	Muu
MFPOS 14 LP 35	50 l/min	350 bar	R 1/4"	1:4,25	1-poolne
MFPOS 38 LP 35	50 l/min	350 bar	R 3/8"	1:4,25	1-poolne
MFPOS 12 LP 35	50 l/min	350 bar	R 1/2"	1:4,25	1-poolne
MFPOB 150 S 35	150 l/min	350 bar	R 3/4"	1:4,25	1-poolne
MFPOD 38 L 35	50 l/min	350 bar	R 3/8"	1:4,25	2-poolne
MFPOD 12 L 35	50 l/min	350 bar	R 1/2"	1:4,25	2-poolne
MOVC DE L 34	90 l/min	280 bar	R 3/4"	1:4,25	2-poolne

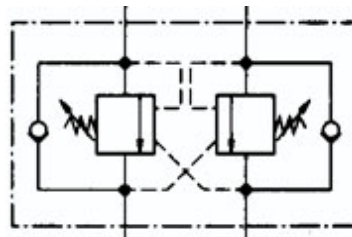
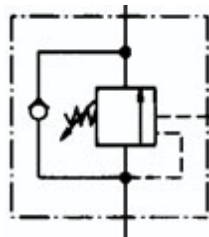

Leevendusventiilid

Tüüp	Vooluhulk	Max surve	Liides
MVEP-VLP 40-38	40 l/min	350 bar	R 3/8"
MVEP-VLP 80-12	80 l/min	350 bar	R 1/2"

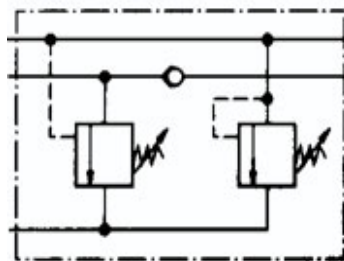
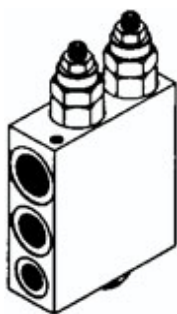

Jälgimisventiilid

Tüüp	Vooluhulk	Max surge	Liides
MVSQ 4038	40 l/min	350 bar	R 3/8"
MVSQ 4012	40 l/min	350 bar	R 1/2"
MVSQ 8034	80 l/min	350 bar	R 3/4"

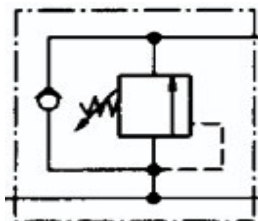
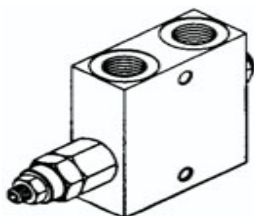

Takistus -vastuventiilid (korpusest seadistatav drossel)

Tüüp	Vooluhulk	Max surge	Liides
MFPMU 14	12 l/min	350 bar	R 1/4"
MFPMU 38	30 l/min	350 bar	R 3/8"
MFPMU 12	45 l/min	310 bar	R 1/2"
MFPMU 34	85 l/min	280 bar	R 3/4"
MFPMU 1	150 l/min	250 bar	R 1"

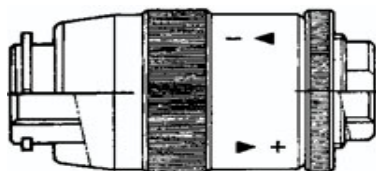

Kaksiklukkustusventiilid bandžo liidesega

Tüüp	Vooluhulk	Max surge	Liides	Avanemissuhe
MVRDE-AZ-015	30 l/min	350 bar	R 3/8"	1:4,5
Bandžoliide	bandžo polt		R 3/8"	RV431.0600
Bandžotoru Ø 12	pikkus 30 mm		R 3/8"	RV535.0603
Bandžotoru Ø 12	pikkus 100 mm		R 3/8"	RV535.0610
Bandžotoru Ø 12	pikkus 400 mm		R 3/8"	RV535.0640

